

- Advanced L2 functions
- Stacking support
- Multicast support (IGMP Snooping, MVR)
- Advanced security functions (L2-L4 ACL, IP Source Guard, Dynamic ARP Inspection, etc.)



The switches provide end users connection to the networks of large enterprises, small and medium-sized businesses and service provider networks using Fast and Gigabit Ethernet interfaces .

The access switches support physical stacking, VLANs and multicast groups, as well as advanced security features.

Uninterruptible power supply¹

MES1124MB and MES2124MB switches have the ability to connect storage battery in order to provide uninterruptible power in case of 220V supply line failure.

The switches are equipped with the power supply unit that allows charging of storage battery if the 220V supply line is available. The power system provides monitoring of power supply line and notifies of power source switching.

Protection against voltage surges

MES switches are equipped with efficient protection technology against voltage surges (up to 6 kV) caused by lightning discharges.

Technical features

	MES1124M	MES1124MB	MES2124M	MES2124MB	MES2124P	MES2124F
Common parameters						
Packet processor	Marvell AlleyCat2					
10/100BASE-T (RJ-45)	24	24				
10/100/1000BASE-T (RJ-45)			24	24		
10/100/1000BASE-T (RJ-45) PoE/PoE+					24	
10/100/1000BASE-X (SFP)						24
10/100/1000BASE-T/1000BASE-X (SFP)	4	4	4	4	4	4
Console port	RS-232/RJ-45					
Performance						
Bandwidth	12.8 Gbps	12.8 Gbps	56 Gbps	56 Gbps	56 Gbps	56 Gbps
MAC table	16K					
The number of active VLANs	4K					
ACL table	512					
Jumbo frames size	10K					
Buffer memory	8 Mb					
L2 Multicast groups (IGMP Snooping)	1K					
Quality of Service (QoS)	4 priority queues					
Max. number of units in stack	3	3	3	3	8	3
Technical features						
Max. power consumption	25 W	25 W	30 W	30 W	400 W	40 W
Max. power consumption while storage battery is being charged		45 W		50 W		

¹ For MB models

Storage battery specification¹

Battery capacity, Ah	Battery life, h	Battery charge time, h
≈12	≈ 4	9
≈17	≈ 6	13
≈20	≈ 7	15

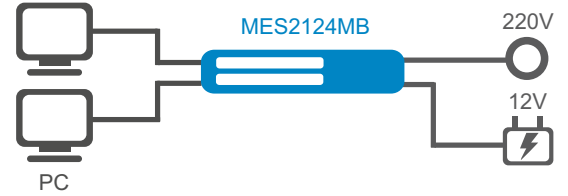

Application diagram

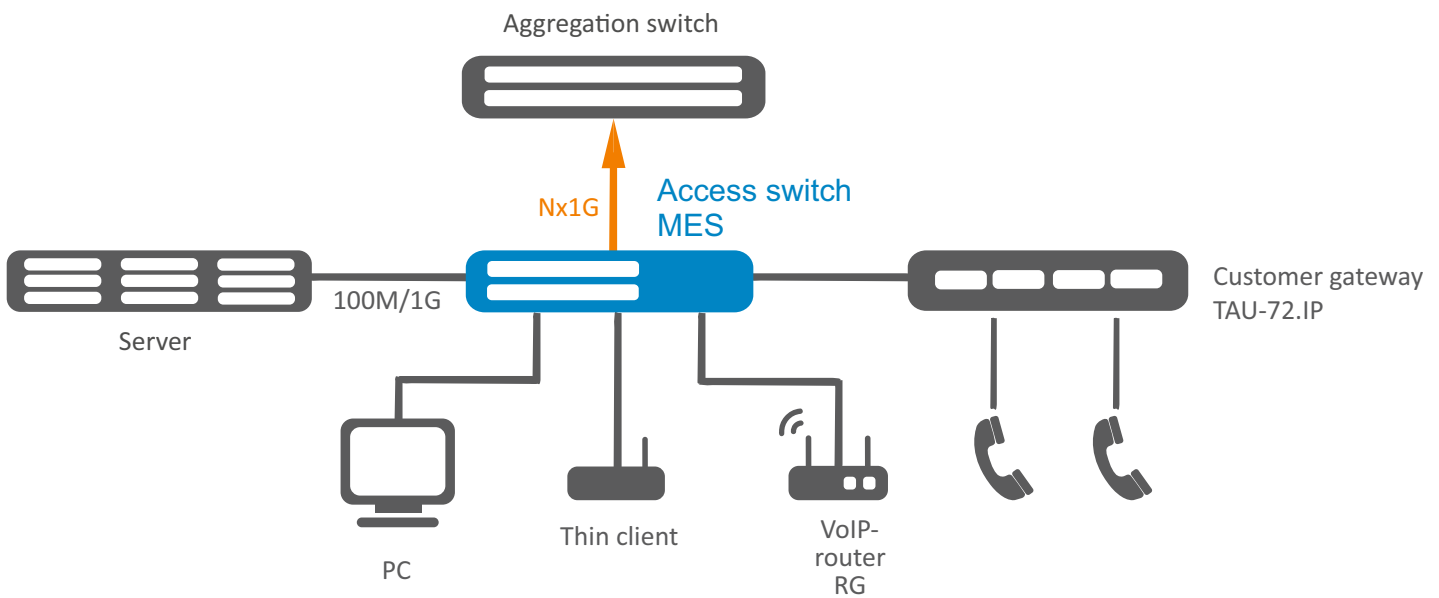

¹ For MB models

Features and capabilities

Interfaces functions

- Head-of-line blocking (HOL) protection
- Back Pressure
- Auto MDI/MDIX
- Jumbo frames
- Flow Control (IEEE 802.3X)
- Port mirroring

MAC table functions

- Independent learning mode per VLAN
- MAC Multicast Support
- Configurable aging time of MAC addresses per VLAN
- Static MAC Entries
- MAC Flapping detection

VLAN functions

- Voice VLAN
- IEEE 802.1Q
- Q-in-Q
- Selective Q-in-Q
- GVRP

L2 Multicast functions

- Multicast profiles
- Static Multicast groups
- IGMP Snooping v1,2,3
- Port/host-based IGMP Snooping Fast Leave
- IGMP authorization via RADIUS
- MLD Snooping v1,2
- IGMP Querier
- MVR

L2 functions

- STP (Spanning Tree Protocol, IEEE 802.1d)
- RSTP (Rapid Spanning Tree Protocol, IEEE 802.1w)
- MSTP (Multiple Spanning Tree Protocol, IEEE 802.1s)
- STP Multiprocess
- STP Root Guard
- STP BPDU Guard
- BPDU Filtering
- Spanning Tree Fast Link option
- Layer 2 Protocol Tunneling
- Private VLAN
- ERPS (G.8032v2)
- EAPS
- Loopback Detection (LBD)
- Port Isolation

Link Aggregation functions

- Static LAG
- Dynamic LAG (LACP)
- LAG Balancing Algorithms

IPv6 functions

- IPv6 Host
- Dual-stack

Service functions

- Virtual Cable Testing (VCT)
- Optical transceiver diagnostics
- Green Ethernet

Security functions

- DHCP Snooping
- DHCP Option 82
- IP Source Guard
- Dynamic ARP Inspection
- sFlow
- MAC-based authentication, Port Security, Static MAC entries
- Port-based authentication IEEE 802.1x
- Guest VLAN
- DoS attack prevention
- Traffic segmentation
- Protection against non-authorized DHCP servers
- DHCP clients filtering
- BPDU attack prevention
- NetBIOS/NetBEUI filtering
- PPPoE Intermediate agent

ACL (Access Control Lists)

- L2-L3-L4 ACL
- Time-based ACL
- IPv6 ACL
- ACL based on:
 - Physical port number
 - IEEE 802.1p
 - VLAN ID
 - Ethertype
 - DSCP
 - Protocol type
 - TCP/UDP port number
 - User Defined Bytes

Quality of Service (QoS) and rate limiting

- QoS statistics
- Shaping, Policing
- IEEE 802.1p Class of Service (CoS)
- Storm Control
- Bandwidth management
- Scheduling algorithms: Strict Priority/Weighted Round Robin (WRR) algorithms
- Three marking colors
- ACL-based CoS/DSCP assignment
- DSCP to CoS remarking

OAM

- IEEE 802.3ah Ethernet Link OAM
- Dying Gasp (only for MES1124M rev.B)
- IEEE 802.1ag Connectivity Fault Management (CFM)
- IEEE 802.3ah Unidirectional Link Detection

Technical features

Management functions

- Download and upload of configuration file via TFTP/SCP
- SNMP
- Command Line Interface (CLI)
- Web interface
- Syslog
- SNTP (Simple Network Time Protocol)
- Traceroute
- LLDP (IEEE 802.1ab) + LLDP MED
- Configuration of user privilege level
- Management interface blocking
- Local authentication
- IP addresses filtering for SNMP
- RADIUS and TACACS+ (Terminal Access Controller Access Control System) clients
- SSH server
- SSL
- Macrocommands
- CLI commands logging via TACACS+
- DHCP autoprovision
- DHCP Relay (IPv4 support)
- DHCP Option 12
- DHCP Relay Option 82
- PPPoE Circuit-ID tag
- Flash File System
- Debugging commands
- Rate limit of traffic to CPU
- Password encryption
- Password recovery
- Ping (IPv4/IPv6 support)
- IPv4/IPv6 static routes for management network
- 2 configuration files

Monitoring functions

- Interface statistics
- RMON/SMON
- CPU utilization monitoring per tasks
- Temperature monitoring
- TCAM utilization monitoring

Uninterruptible power supply¹

- Automatic switching to storage battery (12V) in case of 220V supply line failure and switching back
- Power source type monitoring (including SNMP)
- Notifications of power source switching
- Battery connection indication
- Low battery alarm
- Short circuit failure protection

PoE²

- IEEE 802.3af PoE (up to 15.4 W/port) and IEEE 802.3at PoE+ (up to 30 W/port)
- Automatic and configurable accounting and distribution of PoE power per port
- PoE power budget - 350 W

MIB

- RFC 1065, 1066, 1155, 1156, 2578 MIB Structure
- RFC 1212 Concise MIB Definitions
- RFC 1213 MIB II
- RFC 1215 MIB Traps Convention
- RFC 1493, 4188 Bridge MIB
- RFC 1157, 2571-2576 SNMP MIB
- RFC 1901-1908, 3418, 3636, 1442, 2578 SNMPv2 MIB
- RFC 271,1757, 2819 RMON MIB
- RFC 2465 IPv6 MIB
- RFC 2466 ICMPv6 MIB
- RFC 2737 Entity MIB
- RFC 4293 IPv6 SNMP Mgmt Interface MIB
- Private MIB
- RFC 3289 DIFFSERV MIB
- RFC 2021 RMONv2 MIB
- RFC 1398, 1643, 1650, 2358, 2665, 3635 Ether-like MIB
- RFC 2668 IEEE 802.3 MAU MIB
- RFC 2674, 4363 IEEE 802.1p MIB
- RFC 2233, 2863 IF MIB
- RFC 2618 RADIUS Authentication Client MIB
- RFC 4022 MIB for TCP
- RFC 4113 MIB for UDP
- RFC 3298 MIB for Diffserv
- RFC 2620 RADIUS Accounting Client MIB
- RFC 2925 Ping & Traceroute MIB
- RFC 768 UDP
- RFC 791 IP
- RFC 792 ICMPv4
- RFC 2463, 4443 ICMPv6
- RFC 4884 Extended ICMP to support for Multi-Part messages
- RFC 793 TCP
- RFC 2474, 3260 DS field in the IPv4 and IPv6 header
- RFC 1321, 2284, 2865, 3580, 3748 Extensible Authentication Protocol (EAP)
- RFC 2571, RFC2572, RFC2573, RFC2574 SNMP
- RFC 826 ARP









Technical features

- Power supply: 220 VAC 50 Hz, 48 VDC
- Operating temperature: from -10° to +45°C (for MES1124M from -10°C to +55°C)
- Storage temperature: from -40° to +70°C
- Operating humidity: 80% max
- Passive cooling (except MES2124P and MES2124F)
- Dimensions:
 - MES1124M - 430x158x44 mm
 - MES1124MB - 430x158x44 mm
 - MES2124M - 430x178x44 mm
 - MES2124MB - 430x178x44 mm
 - MES2124P - 430x203x44 mm
 - MES2124F - 430x44x206.5 mm
- Form factor: 19", 1U

¹ For MB models

² For MES2124P series switches

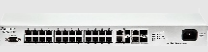
Ordering information

Name	Description	Image
MES1124M AC	Ethernet switch MES1124M, 24 x 10/100BASE-T ports, 4 x 10/100/1000BASE-T /1000BASE-X (SFP) ports, L2, 220 VAC	
MES1124M DC	Ethernet switch MES1124M, 24 x10/100BASE-T ports, 4 x 10/100/1000BASE-T/1000BASE-X (SFP) ports, L2, 48 VDC	
MES1124MB AC	Ethernet switch MES1124MB, 24 x 10/100BASE-T ports, 4 x 10/100/1000BASE-T/1000BASE-X (SFP) ports, L2, 220 VAC, 12 VDC	
MES1124MB DC	Ethernet switch MES1124MB, 24 x 10/100BASE-T ports, 4 x 10/100/1000BASE-T/1000BASE-X (SFP) ports, L2, 48 VDC	
MES2124M AC	Ethernet switch MES2124M, 24 x 10/100/1000BASE-T ports, 4 x 10/100/1000BASE-T/1000BASE-X (SFP) ports, L2, 220 VAC	
MES2124M DC	Ethernet switch MES2124M, 24 x 10/100/1000BASE-T, 4 x 10/100/1000BASE-T/1000BASE-X (SFP) ports, L2, 48 VDC	
MES2124MB AC	Ethernet switch MES2124MB, 24 x 10/100/1000BASE-T, 4 x 10/100/1000BASE-T/1000BASE-X (SFP) ports, L2, 220 VAC, 12 VDC	
MES2124P AC	Ethernet switch MES2124P, 24 x 10/100/1000BASE-T PoE/PoE+, 4 x 10/100/1000BASE-T/1000BASE-X (SFP) ports, L2, 220 VAC	
MES2124F	Ethernet switch MES2124F, 24 x 100/1000BASE-X (SFP), 4 x 10/100/1000BASE-T/1000BASE-X (SFP) ports, L2, 220 VAC	
Relation software		
EMS-MES-access	EMS-MES-access option of Eltex.EMS system for Eltex network elements control and monitoring: 1 network element - access switch	

Contact Us

+7 (727) 320 18 38

info@eltexalatau.kz

www.eltexalatau.kz

About EltexAlatau

EltexAlatau company is one of the first communication equipment manufacturers in Kazakhstan established in 2012. The main focus of the enterprise is a set of solutions and the opportunity of their seamless connection to the customer's infrastructure.